

HT technique – EN 361 – EN 358 – EN 813

Operating and maintenance instructions

English

GB

Fall arrest harnesses and work positioning belts



 **Tractel**®

1

PROMAST

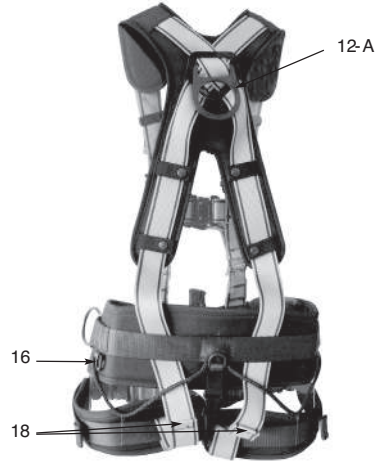
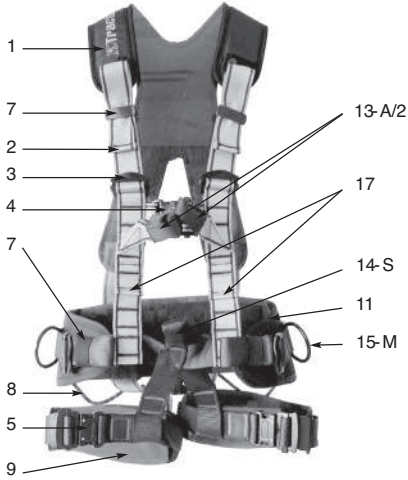

12-A



13-A/2



14-S



15-M



SECOURS

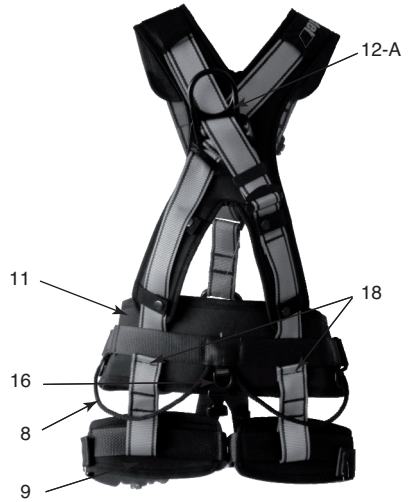

12-A



13-A



14-S



15-M



ELECTRA

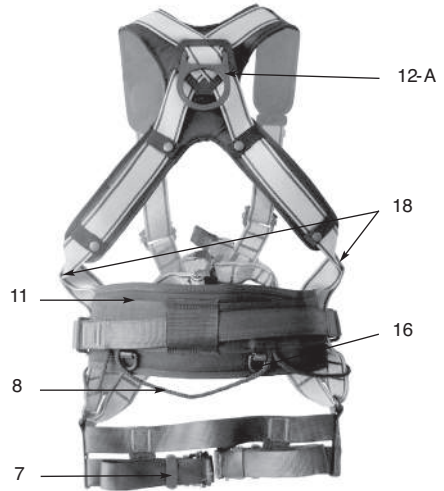
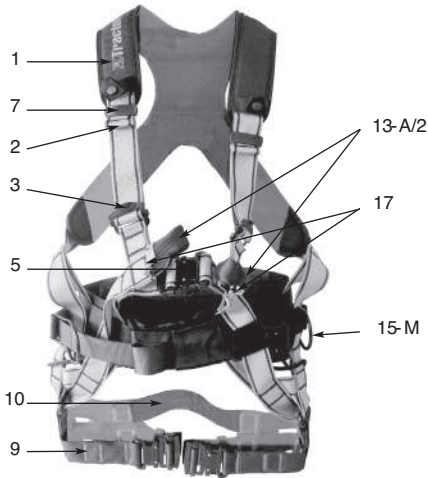

12-A



13-A/2



15-M



EASYCLIMB

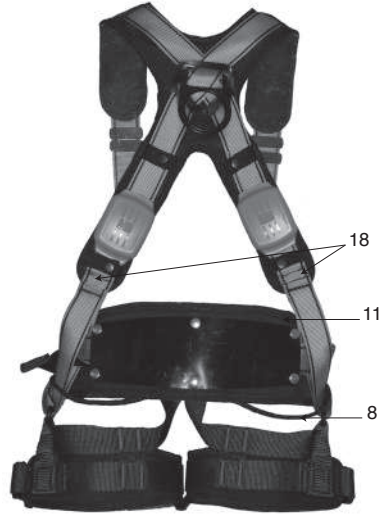
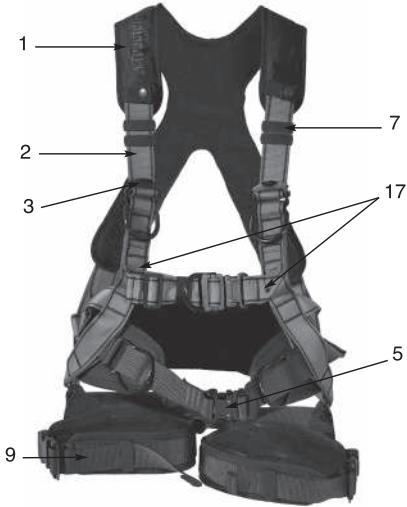

12-A



13-A



13-A



15-M



TRANSPORT / GREENTOOL

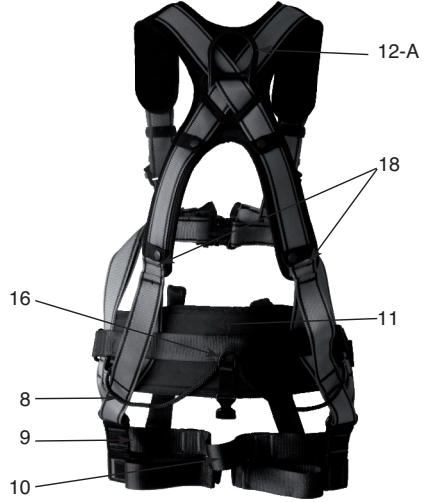
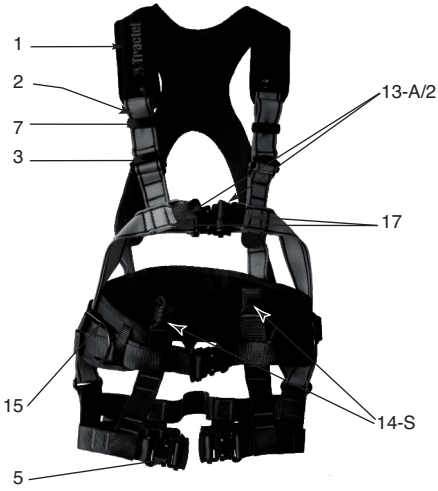

12-A



13-A/2



14-S



15-M



HT54 / HT55 / HT56

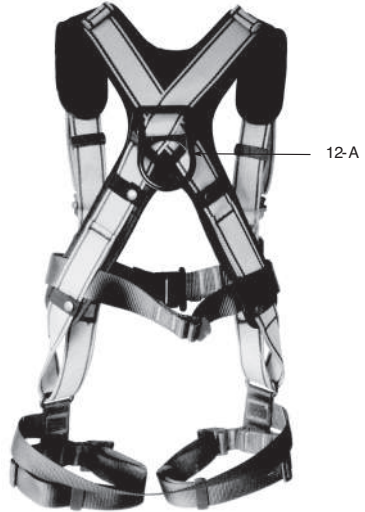
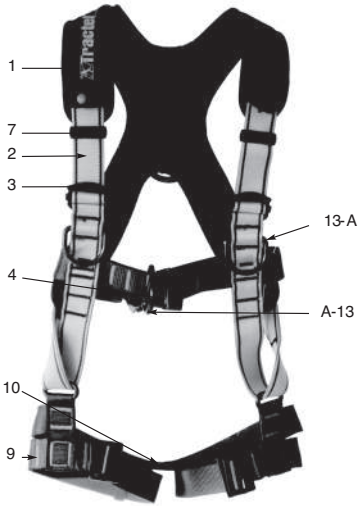

12-A



13-A



13-A



2

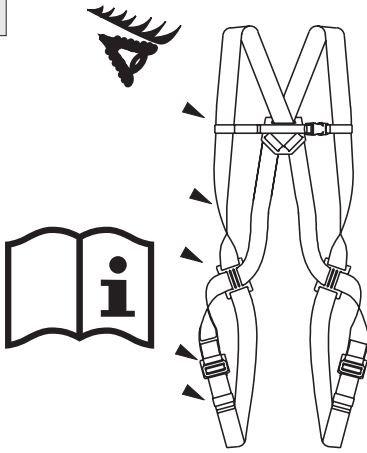

a

3

A

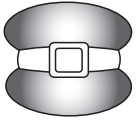

B

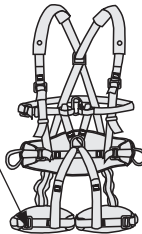
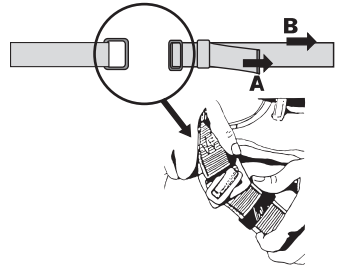
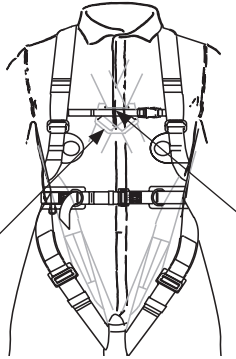
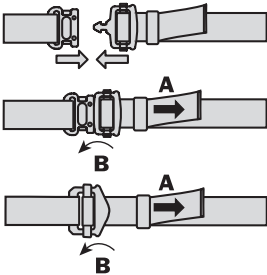
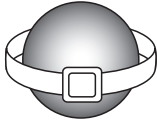

4

	(S)	(M)	(XL)
(A)	60 - 100	80 - 120	100 - 160
(B)	75 - 100	90 - 110	100 - 125
(C)	45 - 80	45 - 100	45 - 120
(D)	55 - 65	65 - 80	80 - 90

5

6

7

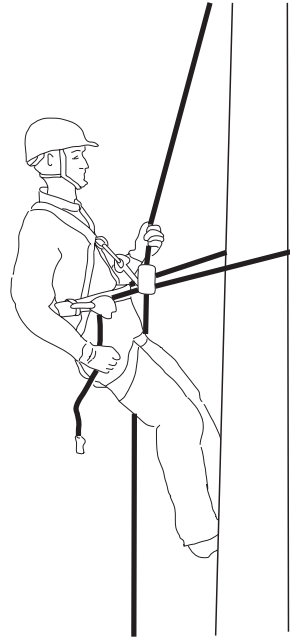
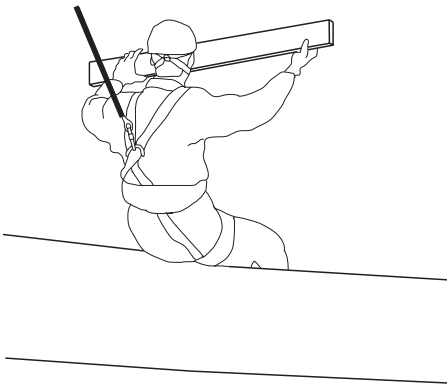
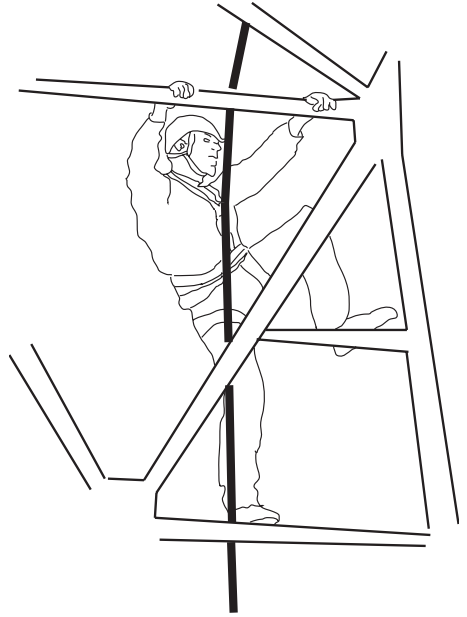
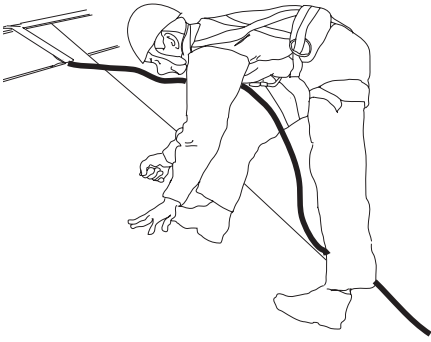

8

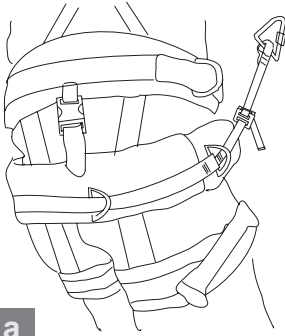

a

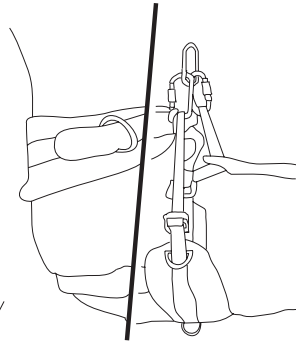

b

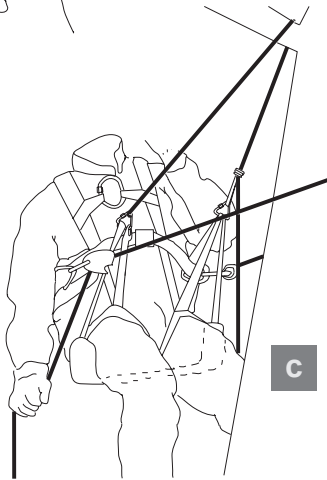

c

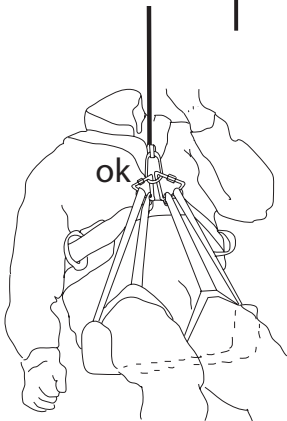

d

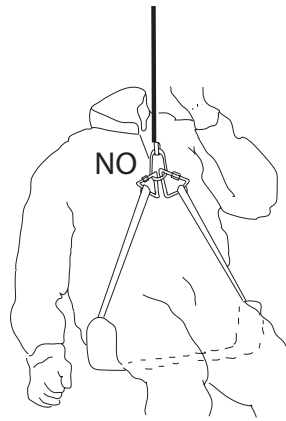

e

Contents	Page
Standard indicators	20
1. General warning	20
2. Definitions and pictograms	21
3. Operation.....	22
4. Functions and description	22
5. Prohibited use	23
6. Installation	24
7. Components and materials	25
8. Associated equipments	26
9. Maintenance and storage.....	26
10. Equipment compliance	26
11. Marking.....	26
12. Periodic inspection and repair	26
13. Lifespan.....	26
14. Disposal.....	26

Standard indicators

To ensure the continuous improvement of products, TRACTEL® reserves the right to make any changes deemed useful for the equipment described in this manual, and this at any time.

The TRACTEL® Group companies and their authorised dealers will provide you with their documentation on the range of other products TRACTEL® upon request, lifting and pulling equipment and accessories, site and facade access equipment, safety devices for loads, electronic load indicators, etc.

The TRACTEL® network can provide after-sales and periodic inspection services.

1. General warning

1. HT harnesses are a component of the fall arrest system. They are EN 361 compliant. They are equipped with belts to maintain position at workstation, in compliance with EN 358. These two types of equipment can only be used by one trained and/or competent person, or by an operator under the direct supervision of such persons.
2. Before using an HT harness, it is essential for the safe and efficient use of equipment that the user read and understand the information in the manual provided by TRACTEL SAS. This manual must be kept available to any user. Additional copies can be supplied on request. A first suspension test is recommended in a safe place, to ensure that the harness is properly adjusted and provides an acceptable level of comfort for the intended use.
3. Before using this safety equipment it is essential to have received training in its use. Check the status of associated equipment and make sure that the clearance is sufficient.
4. If a harness is not in apparent good condition, it must be verified by TRACTEL SAS or by an approved and competent technician, who must authorise further use of the system in writing. A visual inspection is recommended before each use.
5. Any modification or addition to the equipment cannot be achieved without the prior written consent of TRACTEL SAS. The equipment must be transported and stored in its original packaging.
6. All harnesses that have not been subject to periodic inspection in the last 12 months, must not be used. Equipment cannot be used again until a new periodic inspection has been carried out by an approved and competent technician who will authorise its use in writing. Failing such inspection and approval, the harness will be disassembled and destroyed. If it has arrested a fall it must be disassembled and destroyed.
7. The maximum working load is 150 kg for HT harnesses.
8. If the weight of the user increased the weight of their equipment and tooling is between 100 kg and 150 kg, it is imperative to ensure that the total weight (user + equipment + tools) does not exceed the maximum load of each of the components of the fall arrest system.
9. This equipment is suitable for use on site in the open air and at a temperature range between -35°C and +60°C. Avoid contact with sharp edges, abrasive surfaces and chemicals.

10. If you need to assign this material to an employee or similar person, please comply with the pertinent labour laws.
11. The operator must be in top physical and psychological form when using this equipment. If in doubt, consult your doctor or occupational health specialist. It is prohibited for pregnant women.
12. The equipment must not be used beyond its limits or in any other situation than that for which it is intended: see "4. Functions and description."
13. It is recommended to personally allocate the harness to each operator, especially if they are salaried employees.
14. Before using an EN 363 fall arrest system, the user must ensure that each component is in good working order: security system and locks. During installation, there must be no deterioration of safety functions.
15. In a fall arrest system it is essential to check the free space under the operator on the work location before each use, so that in the event of a fall there is no risk of collision with the ground or with any obstacle in the path of the fall
Figure 6c, page 9.
→ **h1** must be between 0 m and 1.5 m.
→ **h2** must be at least 1 m.
→ **t** is the minimum clearance under the operator's feet.
This varies depending on the type of fall arrest connected to the harness:
 - For a blocfor™, **c** = 3 m minimum.
 - For a stopfor™, **c** = 4 m minimum.
 - For a lanyard with shock absorber, **c** = 6 m minimum.
 - For a stopcable™ (EN 353-1), **c** = 2 m minimum.
 - For a stopcable™ (EN 353-2), **c** = 4 m minimum.
16. It is essential to maintain and store the harness in accordance with the instructions provided, failure to comply with the section on maintenance and storage can have a very negative influence on the longevity of the harness.
17. It is essential for the safety of the operator that the device or anchoring point are correctly positioned and that work is carried out so as to minimise the risk of falls and the height thereof.
18. For the safety of the operator, if the product is sold outside the original country of destination, retailers must provide: instructions for use, instructions for maintenance, for periodic inspection and repair in the language of the country where the product will be used.

 **NOTE**

For specialist applications, please contact TRACTEL®.

GB

2. Definitions and pictograms

2.1. Definitions

"User": person or department responsible for the management and safe use of the product described in the manual.

"Technician": qualified person in charge of the maintenance operations described and permitted to the user, who is competent and familiar with the product, by the manual.

"Operator": person involved in using the product as it was intended.

"PPE": personal protective equipment against falls from height.

"Connector": connecting element between the components of a fall arrest system. It complies with EN 362.

"Fall arrest harness": body gripping device intended to arrest falls. It consists of straps and buckles. It comprises fall attachment points marked with an "A" if it can be used alone, or marked with an "A/2" if they are to be used in combination with another "A/2" point. It complies with EN 361.

"Working Load Limit" maximum weight of dressed user, equipped with their PPE, work clothes, tools and components needed to carry out their work.

"Fall arrest system": set consisting of:

- Fall arrest harness.
- Retractable fall arrest or shock absorber or mobile fall arrest on rigid anchor or mobile fall arrest on flexible anchor.
- Anchor.
- Linking component.

"Component of a fall arrest system": generic term defining one of the following:

- Fall arrest harness.
- Retractable fall arrest or shock absorber or mobile fall arrest on rigid anchor or mobile fall arrest on flexible anchor.
- Anchor.
- Linking component.

"Anchor points": points available on a fall arrest harness for the connection of fall arrest systems,

systems to support the worker at the workstation, systems for suspended work.

"Anchor Point": component attached to a structure for attaching the fall arrest system or the EN 795 belay lanyard.

GB

2.2. Pictograms



DANGER: Placed at the start of the line denotes instructions to avoid injury to persons, including death, serious or minor injuries, and damage to the environment.



IMPORTANT: Placed at the start of the line denotes instructions to avoid failure or damage to equipment, but not directly endangering the life or health of the operator or that of others, and/or not being likely to cause environmental damage.



NOTE: Placed at the start of the line denotes instructions to ensure the effectiveness and convenience of an installation, a usage or a maintenance operation.



: Read the instruction manual.



: Wear Personal Protective Equipment (helmet and fall arrest device).



FILL IN THE CONTROL SHEET: Register information on the detachable control sheet located on the central page of this manual.

3. Operation

Check before use:

- Visual check of the condition of the harness, straps, stitching and buckles. The strap, seams should not show any sign of abrasion, fraying, burns or cuts. The adjustment elements, the buckles must not show traces of corrosion, distortion and must function properly. If in doubt, immediately withdraw product from use.
- Check the status of related components.
- Check the entire fall arrest system.

4. Functions and description

- HT harnesses are fall arrest equipment and compliant with EN 361. They can be equipped with an EN 358 belt for securing at the workstation and a thigh strap belt equipped with an EN 813 suspension point.
- HT harnesses are body grippers designed to arrest falls, they are intended to be connected to fall arrest systems, belay lanyards or support lanyards: see

Figure 6 and Figure 7.

- A fall arrest harness is the only body gripper device that is permitted to use in a fall arrest system.

• Attachment points available depending on the type of harness:

Attachment points					
Type of harness	Fall arrest			Support at workstation	Suspension
	Dorsal	Sternal	Thoracic	Lateral	Umbilical
54	1	0	2	0	0
55	1	1	0	0	0
56	1	1	0	1	0
promast	1	1	2	1	1
secours	1	1	0	1	1
electra	1	1	0	1	0
transport	1	1	0	1	1
greentool	1	1	0	1	1
easyclimb	1	1	2	1	0

• Use of HT harnesses according to their anchor points:

- **Dorsal attachment point:** it is designed to receive a fall arrest system or securing lanyard.
- **Sternal attachment point:** it is designed to receive a fall arrest system or securing lanyard. It is recommended for climbing ladders and work on roofs.
- **Lateral attachment points on belt:** they are to receive lanyards to secure the operator at their workstation.

⚠ DANGER: The lateral attachment points must not be used to attach fall arrester systems, they are strictly reserved for securing the person at their workstation (EN 358) in combination with a securing lanyard (EN 358).

⚠ DANGER: In system for securing at the workstation, the lanyard must be kept taut and free movement must be limited to a maximum of 0.6 m.

- **Umbilical attachment point:** it is intended to accommodate accessories for moving on a rope such as clamps or descent devices.

⚠ DANGER: Only attachment items marked "A" or "A/2" if they are connected together to another point marked "A/2" can be used for connecting a fall arrest system. Any connection to another point is dangerous and prohibited.

- **The easyclimb harness** has a thoracic anchor point designed and positioned to connect to a rail mounted fall arrest for ladder work. The particularity of the thoracic anchor point is that in the event of a fall it will move through the tearing of a seam. This principle is patented. It is especially positioned for this application, and cannot hinder the operator during the climb or descent.

- **The greentool harness** is a transport harness equipped with a swing seat which improves user comfort when working in suspension.
- **The swing seat** is an element of comfort for work in suspension. It must always be associated with a fall arrest harness and a fall arrest system.
- **The swing seat** has attachment points for small equipment.

Optional elastrac™ unit: HT harnesses can be equipped with two elastrac™ units attached to the shoulder straps at the back. These units are designed to give elasticity to the 4 cm strap on each shoulder strap.

⚠ DANGER: Do not use the harness for other applications than protection against falls from a height: the use of harnesses as part of a recreational or athletic activity is prohibited.

5. Prohibited use

It is strictly forbidden:

- to use the HT harness if it has the slightest blemish on straps, buckles or seams;
- to use the HT harness without being authorised, trained and approved as competent or failing that, without being under the supervision of an authorised person trained and approved as competent;
- to use the HT harness if the marking is not legible;
- to use an HT harness that has not been the subject of prior inspection;
- to use an HT harness that has not been subject to periodic inspection during the previous 12 months, by a technician who has authorised its continued use in writing;
- to connect an HT harness to a structural anchor point that has not been subject to periodic inspection during

the previous 12 months, by a technician who has authorised its continued use in writing;

- to use an HT harness for any other application than protection against people falling from heights;
- to connect an HT harness at any point other than one of its anchor points;
- to use an HT harness in contradiction with the information defined in the section "13. Lifespan";
- to use an HT harness for a person whose weight, including equipment and tools, is greater than 150 kg;
- to use the HT harness for a load of between 100 kg and 150 kg (total weight of the user, its equipment and its tools) when a component of fall arrest system has a lower working load;
- to use an HT harness that has arrested a fall;
- to use an HT harness in a highly corrosive or explosive atmosphere;
- to use an HT harness outside the temperature range specified in this notice;
- to use an HT harness if the vertical clearance is not enough should a person fall;
- to use an HT harness if there is an obstacle in the path of the fall;
- to use an HT harness if you are not in top physical condition;
- to use an HT harness if you are a pregnant woman;
- to use an HT harness if the safety function of one of the associated items is affected by the safety function of another item or interferes therewith;
- to use an HT harness if the strap could be in contact with sharp edges;
- to use an HT harness if a fall indicator has been triggered: see Figure 2.a;
- to anchor the fall arrest system to a structural anchor whose resistance is less than 10 kN;
- to use an HT harness if it is not complete, it has been dismantled beforehand or if components have been replaced or modified;
- to use an HT harness if a rescue plan has not been prepared;
- to use an HT harness if all buckles are not properly locked;
- to use an HT harness if the straps are not adjusted correctly for the user;
- to use an HT harness if the fall arrest system is not properly connected to the anchor point;
- to use an HT harness if the connector linking the fall arrest system is not properly locked;
- to connect a fall arrester to a point that is not marked "A" or "A/2";
- to use an HT harness if only one anchor point marked "A/2" is connected to the fall protection connector;
- to use an HT harness equipped with elastrac™ units if they are not working properly or if they are broken;
- to work suspended on a swing seat without a fall arrest harness and a fall arrest system properly installed and used (Figure 8.e);
- to use a swing seat if the straps are not correctly adjusted;

- to use a swing seat if the fast attachment links are not properly attached to the suspended working system;
- to work using a swing seat if you are not safely seated in it;
- to work suspended if the operator was not trained for this kind of use;
- to work suspended if the operator is not declared medically fit for this type of intervention.

Other misuses are not listed in this list. A multitude of other misuses exist that we cannot list or imagine. If in doubt or misunderstanding of this manual, check with TRACTEL®.

6. Installation

6.1. Checks before use



IMPORTANT: Check on the harness that:

- The strap and seam stitching is in perfect condition.
- The strap and seam stitching show no signs of abrasion, unraveling, burns or cuts.
- The adjusting components, the buckles do not show any signs of corrosion or distortion and operate and lock correctly.
- The elastrac™ units are working properly: elongation and retraction of the strap over a 4 cm distance.

If in doubt, withdraw the HT harnesses from use or destroy it.



DANGER: Check that the fall arrest indicator labels are not visible: see Figure 2.a. The fall arrest indicators are placed on the rear of the shoulder straps and on the sternum and thoracic fall arrest points. See photos of the various harnesses at the beginning of this manual to see their exact location. If they are exposed, the HT harness has been used to arrest a fall. It must be withdrawn from use and destroyed.

• Check out associated components:

The fall arrest system, lanyard, connectors, and other associated systems that they do not present a danger in use. For this, refer to the specific instructions for each product.

6.2. Implementation and use

Setting up the harness:

- Select the most appropriate harness depending on the risk analysis that was carried out for the work to be done.
- Put on the harness positioning straps flat against the body.
- Lock all closing buckles on the harness: See Figure 3.
- Adjust the lengths of the different straps: neither too tight nor too slack in order to obtain maximum comfort during use and optimal fall protection. This is the condition that the harness will protect efficiently: See

Figure 3.

To tighten the straps, pull the free end A: Figure 3, to loosen the straps, pull on the adjustment buckle B.

For sizes: See Figure 4.

- Select the most suitable anchor point on the harness to receive your fall arrest system based on the work to be performed (Figures 7.a to 7.f).

 **NOTE:** Wherever possible, the anchor point will be located above the user. The anchor point must have a minimum strength of 10 kN or comply with EN 795.

Before using the harness:

- Perform an initial suspension test in a safe place, to ensure that the harness is properly adjusted and that it provides an acceptable level of comfort for the intended use.
- Check the connection to an anchor point or structure is made using an EN 362 connector.
- Verify that the fall arrest system is attached to the harness using an EN 362 connector on a connection point marked with an "A" or two attachment points marked "A/2".
- The attachment points of the HT harness marked "A/2" are symmetrical and must be linked together by using an EN 362 connector: see figures at the beginning of this manual, the whole thing must be connected to the fall arrest system.

 **DANGER:** Points not marked "A" or "A/2" are points to secure to the worksite or suspension points. They should not be used for fall protection.

 **DANGER:** Check the correct locking of all the buckles and connectors before use. Figure 6.a and 6.b.

 **DANGER:** Check that the clearance is sufficient and that there is no risk of collision with an obstacle in the path of the fall. The clearance is that of the fall protection system used (refer to the manual of the fall arrest system used) to which you should add 1m for safety: see Figure 6.c.

 **DANGER:** Before and during use, you should consider how any rescue could be provided effectively and safely within less than 15 minutes. Beyond this time, the operator is in danger.

Using when suspended:

- Work in suspension is reserved for trained operators with specific authorisation for such use.
- The height of intervention, the presence of the drop can have traumatic effects. The operator must have been declared medically fit for this type of intervention.
- When using a harness equipped with a thigh strap belt, the operator must change the position of the straps on the thighs to avoid the risk of cutting off the blood supply and experiencing pins and needles.
- When in suspended use of a harness equipped with a

thigh strap belt, it is imperative to regularly check and adjust attachment items during use.

Setting up the swing seat:

- Hook the two connectors (EN 362) at the end of the harness straps to the suspended work system (figure 8.b).
- Adjust the strap length for optimum comfort while working.
- Always use the harness in conjunction with a fall arrest harness (Figures 8.c – 8.d).

Attaching the swing seat for walking:

- Attach the swing seat to the harness belt with the plastic buckle (Figure 8.a).

 **DANGER:** before using a swing seat, make sure it is compatible with the associated equipment. If in doubt, contact TRACTEL®.

7. Components and materials

7.1. Names of parts

1. X-Pad.
2. Shoulder strap.
3. Shoulder strap adjustment.
4. Thoracic buckle.
5. Automatic buckle.
6. Label.
7. Elastic pass band.
8. Tool holders.
9. Thigh strap belt.
10. Seat strap.
11. Back support.
12. Dorsal attachment element.
13. Sternal attachment element.
14. Ventral attachment element.
15. Lateral attachment element.
16. Service ring.
17. Sternal fall arrest indicator.
18. Dorsal fall arrest indicator.

7.2. Designation of attachment points

References used in the HT harnesses to designate the different attachment points:

- **A:** the marking "A" on attachment points designates them for fall arrest systems.
- **A/2:** the marking "A/2" on the attachment points designates them for fall arrest systems to be coupled symmetrically to each other with an EN 362 connector to make one single attachment point.
- **M:** designates an attachment point for securing at the workstation (35B).
- **S:** designates a suspension attachment point for work on tensioned rope (EN 813).

7.3. Materials

- Strap + sewing thread: polyester.
- Buckles made of galvanized steel or cataphoresis and aluminium coating.
- Foam back support covered with cordura.
- Backplate, loops: polyethylene, thermoplastic elastomer.

8. Associated equipments

Fall arrest system (EN 363)

- An anchor (795).
- An end connector (EN 362).
- A fall arrest system (EN 353-1/2 – EN 355 – EN 360).
- A connector (EN 362).

Before using an EN 363 fall arrest system, check that each component is usable and functioning properly.

9. Maintenance and storage

- If a harness is dirty, clean it in clear, cold water possibly with a detergent for delicate textiles, using a synthetic brush: see Figure 5.a.
- If during use or washing a harness gets wet, leave it to dry naturally in the shade and away from any heat source: see Figure 5.b.
- During transportation and storage, protect the equipment against the risk of attack (sharp edge, direct heat, chemicals, UV, etc.): see Figure 5.c.

10. Equipment compliance

TRACTEL SAS. - RD 619 - Saint-Hilaire-sous-Romilly - F-10102 Romilly-sur-Seine, France, hereby declares that the safety equipment described in this leaflet:

- complies with the provisions of European Directive 89/686 / EEC of December 1989;
- is identical to the PPE which was the subject of the EC type examination issued by APAVE SUDEUROPE SAS - CS 60193 - 13322 Marseille Cedex 16 - France, identified by the number 0082, and tested according to EN 361 2002; EN 358 and EN 813 from 1999 to 2008;
- is subject to the procedure laid down by Art. 11 B of Directive 89/686/EEC, under the control of a notified body: APAVE SUDEUROPE SAS - CS 60193 - 13322 Marseille Cedex 16 - France, identified by the number 0082.

11. Marking

The label of each harness indicates:

- The trademark: TRACTEL®;
- The product description;
- The reference standard followed by the year of application;
- Product reference: e.g. 010642;
- CE Logo followed by the number 0082, identification number of the approved body responsible for

- production control;
- Year and week of manufacture;
- The serial number;
- An icon indicating that it is necessary to read the instructions before use;
- Maximum working load.

12. Periodic inspection and repair

An annual periodic inspection is required, but depending on the frequency of use, environmental conditions and regulations of the company or the country of use, periodic inspections may be more frequent.

Periodic inspections shall be carried out by an authorised and competent technician and in accordance with the manufacturer's examination procedures transcribed in the "Inspection Instructions for TRACTEL® PPE".

Verification of the legibility of the marking on the product is an integral part of the periodic inspection.

Following the periodic examination, the return to service must be notified in writing by the authorised and competent technician who performed the periodic inspection. This product release to service must be recorded on the control sheet which is in the middle of this manual. This control sheet should be retained throughout the life of the product until it is scrapped.

After arresting a fall, this textile product must be scrapped and destroyed, even if there is no visible alteration.

13. Lifespan

TRACTEL® textile PPE such as harnesses, lanyards, ropes and shock absorbers, TRACTEL® mechanical PPE such as stopcable™ and stopfor™ fall arresters, the self retracting fall arrest blocfor™ and TRACTEL® lifelines can be used provided that from the date of manufacture they are subject:

- to normal use in accordance with the recommendations of use of this manual;
- periodic inspection, which must be performed at least once a year by an authorised and competent technician. At the end of this periodic inspection, the PPE must be declared fit to return to service in writing;
- strict compliance with storage and transport conditions specified in this manual.

14. Disposal



At the final withdrawal of the product, it is mandatory to recycle the various components by sorting metallic materials and by sorting synthetic materials. These materials should be recycled by specialised bodies. During withdrawal, dismantling, for the separation of components must be performed by a competent person.

Lined writing area with 20 horizontal lines.

Feuille de contrôle – Inspection sheet – Kontrollkarte – Controloblaid – Hoja de revisión – Scheda di revisione – Folha de controlo
Δελτίο ελέγχου – Kontrollskjema – Kontrollblad – Tarkastuslista – Kontrolblad – Karta kontrolna – Контрольный листок

Type de produit Type of product Produktbezeichnung Tipo de producto Tipo de produto Τύπος προϊόντος Προϊκτύπη Tuotetyyppi Typ produktu Тип изделия	Référence produit Product reference Codenummer Produktcode Referencia producto Referencia do produto Κωδικός προϊόντος Produktreferanse Tuotteen viitenumero Produktnummer Oznaczenie produktu Номер изделия	Número de série Serial number Seriennummer Número de serie Número de produto Σειριακός αριθμός Seriennummer Sarjanumero Numar seriyul Номер Серии	Nom de l'utilisateur Name of user Name des Benutzers Naam van de gebruiker Nome dell'utente Nome dell'utilizator Nome do utilizador Όνομα του χρήστη Brukerens navn Användarens namn Käyttäjän nimi Brugerens navn Nazwisko użytkownika Фамилия пользователя
Date de fabrication Date of manufacture Herstellungsdatum Fabricagedatum Fecha de fabricación Data di produzione Data de fabrico Κατασκευαστικό Fabricasjonsdato Tilværingstidspunkt Valmistusajankohta F. abrikationsdato Data produkcji Дата производства	Date d'achat Date of purchase Kaufdatum Aankoopdatum Fecha de compra Data de compra Data di acquisto Κατασκευαστικό Κηροδοτο Inkopsdatum Ostloppålv Købsdato Data zakupu Дата покупки	Date de mise en service Date of first use Datum der Inbetriebnahme Datum ingebruikneming Fecha de puesta en servicio Data di messa in servizio Data de entrada em serviço Data de primeira utilização Data for bruk første gang Första användningsdagen Καυτόόχροντοπάλω Dato for ibrugtagning Data przekazania do użytku Дата ввода в эксплуатацию	

Verificação – Έλεγχος – Kontroll – Prüfung – Contrôle – Verificaciones – Verifiche
Verificação – Έλεγχος – Kontroll – Prüfung – Contrôle – Eftersyn – Kontrola – Проверка

Date Dato Datum Datum Fecha Data Data Ημερομηνία Dato Datum Pälv Dato Dato Data	 	Date du prochain examen Date of next inspection Datum der nächsten Prüfung Datum van het volgende onderzoek Fecha del próximo examen Data della prossima ispezione Data do próximo exame Ημερομηνία του επόμενου ελέγχου Dato for neste kontroll Næste inspektionsdatum Dato for næste undersøgelse Data następnego przeglądu Дата следующего проверки	Nom du contrôleur Name of inspector Name des Prüfers Naam van de controller Nombre del controlleur Nome del controllore Όνομα του ελεγκτή Nome do controlador Kontrollörens navn Besiktningmannens navn Tarkastajan nimi Kontrollörrens namn Nazwisko kontrolującego Фамилия проверяющего	Visa Signature Unterschrift Gezien Firma Firma Visto Ösajörten Visa Stampel Hyväksymä Underskrift Podpisane Виза	

Réparation – Repairing
Reparatur – Herstelling
Reparación – Riparazione
Reparação – Επιδιόρθωση
Reparasjon – Reparation
Korjaus – Reparation
Нарправа – Починка

Lined writing area with 20 horizontal lines.

Lined writing area with 20 horizontal lines.